

**Shively Labs<sup>®</sup>**

# Vertically Polarized FM Broadcast Antenna

Model 6513

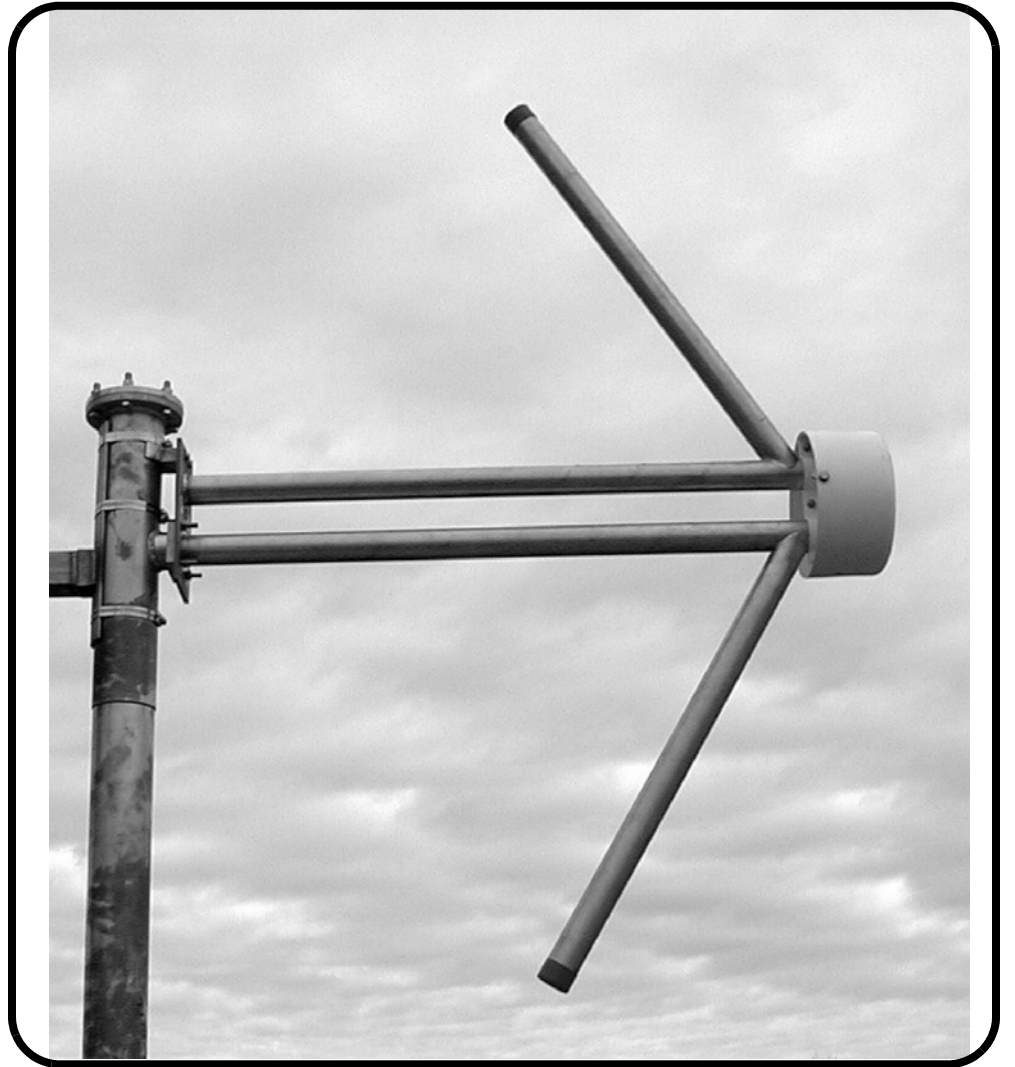

Instruction Manual  
Installation, Operation,  
& Maintenance

---

## Congratulations!

Thank you for purchasing one of the finest FM broadcast antennas on the market today. The Shively Labs Model 6513 is widely recognized as the top-of-the-line in its class for its superior performance and durability.

Your purchase is backed by the best technical support in the industry. Shively is a leading manufacturer in the broadcast industry, providing an extensive range of antennas, transmission line and components. Our technical staff has a wealth of experience and is standing by to serve you in any way.

This manual is intended to give you a good basic understanding of your antenna: its proper and safe installation, startup, and operation, and troubleshooting and maintenance information to keep it working satisfactorily for years to come. Please have everyone involved with the antenna read this manual carefully, and keep it handy for future reference.

Meanwhile, please feel free to contact your sales representative at Shively Labs at any time if you need information or help. Call or write:

# Shively Labs®

A Division of Howell Laboratories, Inc.

Bridgton, Maine 04009 USA

188 Harrison Rd., P. O. Box 389, Bridgton, Maine 04009 USA

(207) 647-3327

1-888-SHIVELY

24-hour (207) 329-5118

FAX (207) 647-8273

sales@shively.com

www.shively.com

An Employee-Owned Company

ISO 9001 Certified

Publication No. im-6513 (150520)

---

**IMPORTANT**

**Please read this manual in its entirety before beginning installation of your antenna!**

**Failure to follow the installation and operation instructions in this manual could lead to failure of your equipment and might even void your warranty!**



---

## Table of Contents

<b>Chapter 1 Preparing for Installation</b> .....	<b>1</b>
Receiving.....	1
Unpacking .....	1
Check the System .....	1
<b>Chapter 2 Installing the Radiators</b> .....	<b>3</b>
Before Beginning Radiator Installation: .....	3
Installation Procedure.....	3
<i>Figure 1 Baymount Detail</i> .....	4
<i>Figure 2 Radiator Installation, exploded view</i> .....	4
<i>Figure 3 Flange Bolt Tightening Sequences</i> .....	5
<i>Table 1 Torque Specifications, Flange Bolts</i> .....	5
<b>Chapter 3 Installing Feedline and Transformer</b> .....	<b>7</b>
Before Beginning Feedline and Transformer Installation:.....	7
<i>Figure 4 Feedline Flange Detail</i> .....	7
Installing the Feedline Mounts.....	8
<i>Figure 5 Common Mounting Styles</i> .....	8
<i>Figure 6 Common Feedline Mount Configurations</i> .....	9
Installing the Feedline Sections .....	10
Installing the Transformer .....	11
<i>Figure 7 Transformer Installation, top view</i> .....	11
<b>Chapter 4 Startup</b> .....	<b>13</b>
Before Beginning Startup:.....	13
Pressurization .....	14
Leak Testing .....	14
<i>Figure 8 Pressurized Gas Schematic</i> .....	15
Purging the System .....	15
<i>Table 2 Volume of Coax per 1000 Feet of Length</i> .....	16
Leaving the System Pressurized.....	16
Initial Characterization (recommended) .....	17
Transmission Line VSWR Reading.....	17
Transmission Line TDR Reading.....	17
System VSWR Reading .....	17
Checking Radiator Function.....	17
Adjusting the Transformer (Impedance Trimming).....	18
<i>Figure 9 Impedance-Matching Transformer</i> .....	18
<i>Table 3 Factory Control Rod Settings</i> .....	18
Checkout .....	19
<b>Chapter 5 Operation</b> .....	<b>21</b>
Precautions.....	21
The Antenna.....	21

---

## Table of Contents

<b>Chapter 6 Troubleshooting</b> .....	<b>23</b>
Precautions.....	23
Internal Arcing.....	23
<i>Table 4 Troubleshooting Internal Arcing</i> .....	<i>23</i>
Broad Spectrum RF Noise .....	23
High VSWR at Startup or during Operation.....	24
<i>Table 5 Troubleshooting High VSWR</i> .....	<i>24</i>
Erratic VSWR During Transformer Adjustment (Impedance Trimming) ....	25
Change in Coverage .....	25
Pressure Loss or Excessive Gas Usage .....	25
<i>Table 6 Troubleshooting Pressure Loss or Excessive Gas Usage</i> .....	<i>25</i>
<b>Chapter 7 Maintenance</b> .....	<b>27</b>
Precautions.....	27
Maintenance Log.....	27
Physical Inspection.....	27
Paint .....	28
Radiator Removal for Repair .....	28
Troubleshooting .....	28
Return Policy .....	28
Sample Maintenance Log .....	29

# 1

## Preparing for Installation

---

### Receiving

As soon as you receive your antenna, *BEFORE* signing for the shipment:

- a. Check to be sure all the material has arrived.

#### **NOTE**

The box number and the total number of boxes are marked on each box; for example, "Box 2 of 5" means "box number 2 of a total of five boxes."

- b. Check for evident damage to any of the boxes.
- c. If any boxes are missing, or if any are obviously damaged, describe the problem in a WRITTEN note on the shipping papers BEFORE signing them. Then call Shively right away, and we'll do everything we can to correct the situation.

#### **Important!**

Never store the antenna system outdoors, boxed or otherwise. Take pains to keep the antenna components dry. You will need to purge moisture from the interior of the antenna components before applying transmitter power, and purging will be much more time-consuming if the components get wet.

---

### Unpacking

- a. Find Box 1; it is marked "Open This Box First." It contains the transformer and two copies of the installation drawing. The parts list on one sheet of the installation drawing shows what box each item is in.
- b. Then open the boxes and examine for shipping damages. File any necessary claims with the carrier immediately.
- c. If all the boxes are present and in good condition but material seems to be missing, please contact Shively Labs immediately, using the telephone or Fax number on the inside cover of this manual. For the best service, have our shop order number (S/O) handy; it's in the block at the bottom right corner of the installation drawing.
- d. Along with your antenna you will get a spare parts kit. Place this in a safe place until it is needed.

#### **CAUTION**

All contact surfaces and openings to the interior of the components are protected from contamination and from physical damage by caps and plastic bags. Do not remove this protection until ready to connect the components.

---

### Check the System

#### **Remember!**

*It is YOUR responsibility to ensure that your installation meets all applicable codes and the centerline-of-radiation requirements of your FCC construction permit.*

Shively's factory designer has planned the installation of the antenna based upon information provided by you. If this information contained errors, the parts and mounting hardware will have been designed incorrectly and will cause expensive delays in installation. *Therefore, we recommend that you recheck the installation parameters during this planning stage.*

## Preparing for Installation

Check all the parts to be sure that they will fit the tower and each other. Study the installation drawings carefully to confirm that the information used in designing the antenna and mounts was, in fact, accurate.

Have a reliable tower person, familiar with antennas and coaxial line, inspect the tower and review the installation drawings before the full rigging crew arrives.

If design problems are found, contact Shively Labs immediately. Pay particular attention to:

- Frequency of the antenna.
- Fit of the mounts to the tower members.
- Freedom from interference by gussets, leg flanges, guys and their attachment points, tower face members, obstruction lights, and other components.
- Compatibility of transmission line and antenna input terminals.
- Location of the transmission line run relative to the antenna input terminal.
- Use of non-metallic guy sections on the tower in the region to be occupied by the FM antenna. Ensure that there are no metal guys within ten feet (three meters) of any radiator.
- Availability of proper electrical service for deicers, if applicable.
- The adequacy of the tower structure and guys to carry the wind-load placed upon them by the antenna, particularly if radomes are used.

You gave Shively this information at the time of purchase, but a last check at this time can catch an error, which will be easier to correct before installation begins.



## Before Beginning Radiator Installation:

### Important!

Bay orientation is critical to performance. In general, the bays in a full-wave-spaced antenna will all be oriented the same, while those in a half-wave-spaced antenna will alternate, with every even-numbered bay rotated 180°. *Install each radiator in accordance with its stenciled bay numbers and its "up-arrow" sticker.*

### CAUTION

All contact surfaces and openings to the interior of the components are protected from contamination and from physical damage by caps and plastic bags. Do not remove this protection until ready to connect the components.

### CAUTION

Do not use silicone grease on an O-ring, as this will soften the silicone O-ring.

Use only a light lubricating coat of petroleum jelly (provided); too much may hamper electrical contact and contaminate the interior of the system.

Be sure the O-ring is properly seated in its groove and not pinched between the flange contact surfaces.

## Installation Procedure

It will be easiest to mount the radiator onto the feedline section before the feedline is mounted on the tower.

- a. Lay the feedline horizontally, supported off the ground, with its baymount flange pointing upwards.
- b. Secure the feedline section at the brass end, using hose clamps, to prevent its turning with the weight of the radiator.

### CAUTION

To prevent damaging the copper feedline, use hose clamps rather than U-bolts, and don't overtighten.

- c. Remove the plastic bag and protective cover (see [Figure 1](#)) from the baymount flange on the feedline.
- d. Make sure the inner conductor connector is in place and secure in the inner conductor of the baymount flange.

### NOTE

The hardware is shipped in place on the baymount flange.

- e. Remove the O-ring and coat it lightly with petroleum jelly (supplied with the antenna), then reinstall it in the O-ring groove in the flange.
- f. Make sure an inner conductor connector is in place in the inner conductor of the line section.

## Installing the Radiators

Figure 1. Baymount Detail

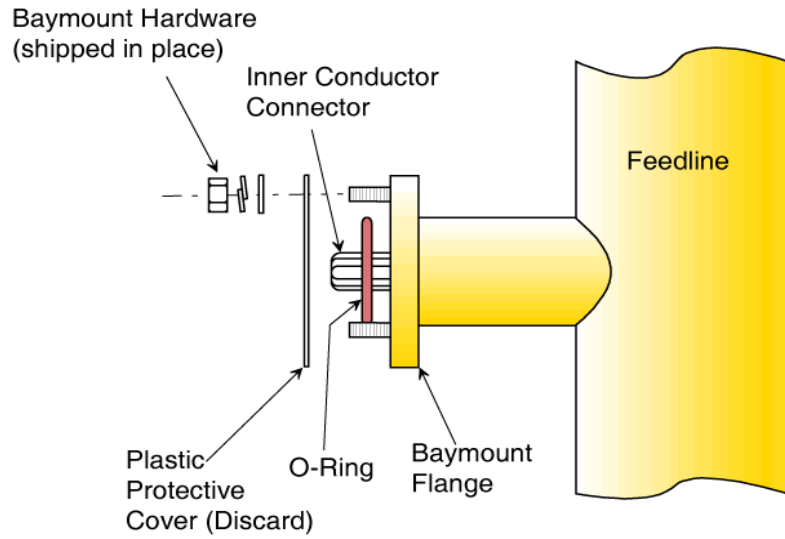
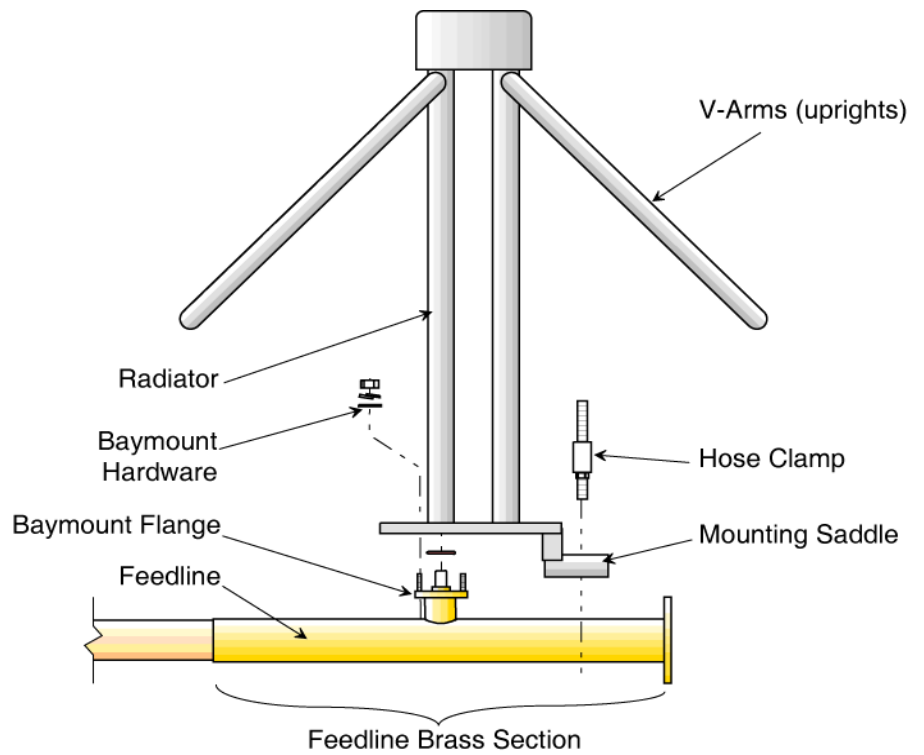

Figure 2. Radiator Installation, exploded view



## Installing the Radiators

- g. Remove the radiator assembly from its protective plastic bag.

### CAUTION

Be sure the radiator's inner conductor fits cleanly over the baymount's inner conductor connector. If any of the fingers of the connector are forced outside the radiator's inner conductor (we call this a "split bullet"), this may cause arcing and damage to the antenna.

- h. Observing the orientation of the bay's "UP" sticker, carefully place the radiator over the flange studs (see [Figure 2](#)), and slip it over the inner conductor connector.
- i. First snug the flange bolts in the sequence shown in [Figure 3](#) on page 5, then tighten them to the torque specification shown in [Table 1](#) on page 5.

Figure 3. Flange Bolt Tightening Sequences

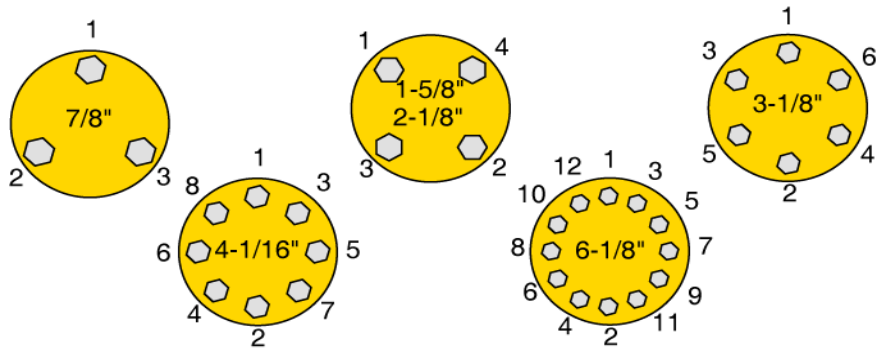

Table 1. Torque Specifications, Flange Bolts

Transmission Line Size	Bolt Size	Torque	
		ft-lb	N-m
7/8"	1/4-20	7 ft-lb	9 N-m
1-5/8"	5/16-18	12 ft-lb	16 N-m
2-1/8"	3/8-16	21 ft-lb	28 N-m
3-1/8"	3/8-16	21 ft-lb	28 N-m
4-1/16"	3/8-16	21 ft-lb	28 N-m
6-1/8"	3/8-16	21 ft-lb	28 N-m

- j. Clamp the mounting saddle to the feedline, using a hose clamp.



## 3

## Installing Feedline and Transformer

### Before Beginning Feedline and Transformer Installation:

Figure 4. Feedline Flange Detail

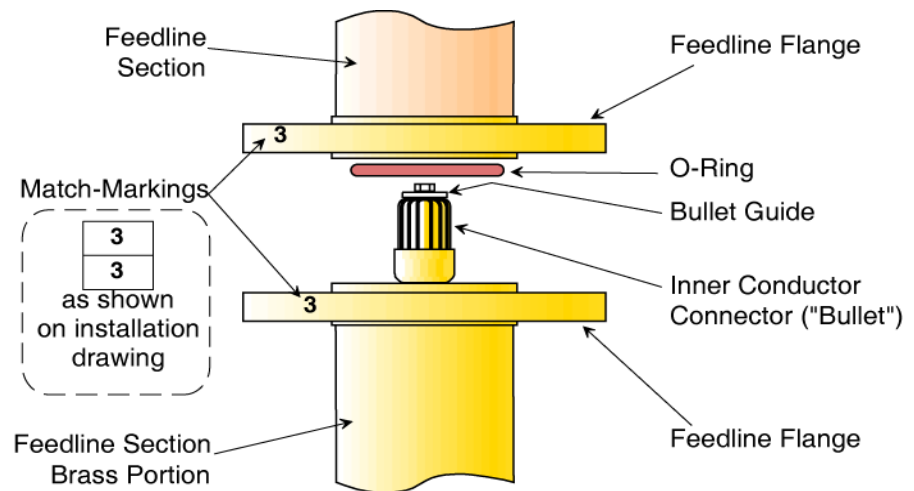
**CAUTION**

The feedline inner conductors include "bullet guides" (see [Figure 4](#)) to help prevent split bullets. Be sure the bullet guides are in place before assembly.

**CAUTION**

If you don't get good electrical contact between the mounts and the tower, the antenna may not perform as designed, and may produce stray signals that will interfere with other services on the tower.

**CAUTION**

All contact surfaces and openings to the interior of the components are protected by covers and plastic bags. DO NOT expose these openings and contact surfaces until ready to connect the components.

**CAUTION**

Do not use silicone grease on an O-ring, as this will soften the silicone O-ring.

Use only a light lubricating coat of petroleum jelly (provided); too much may hamper electrical contact and contaminate the interior of the system.

Be sure the O-ring is properly seated in its groove and not pinched between the flange contact surfaces.

## Installing the Feedline Mounts

Figure 5. Common Mounting Styles

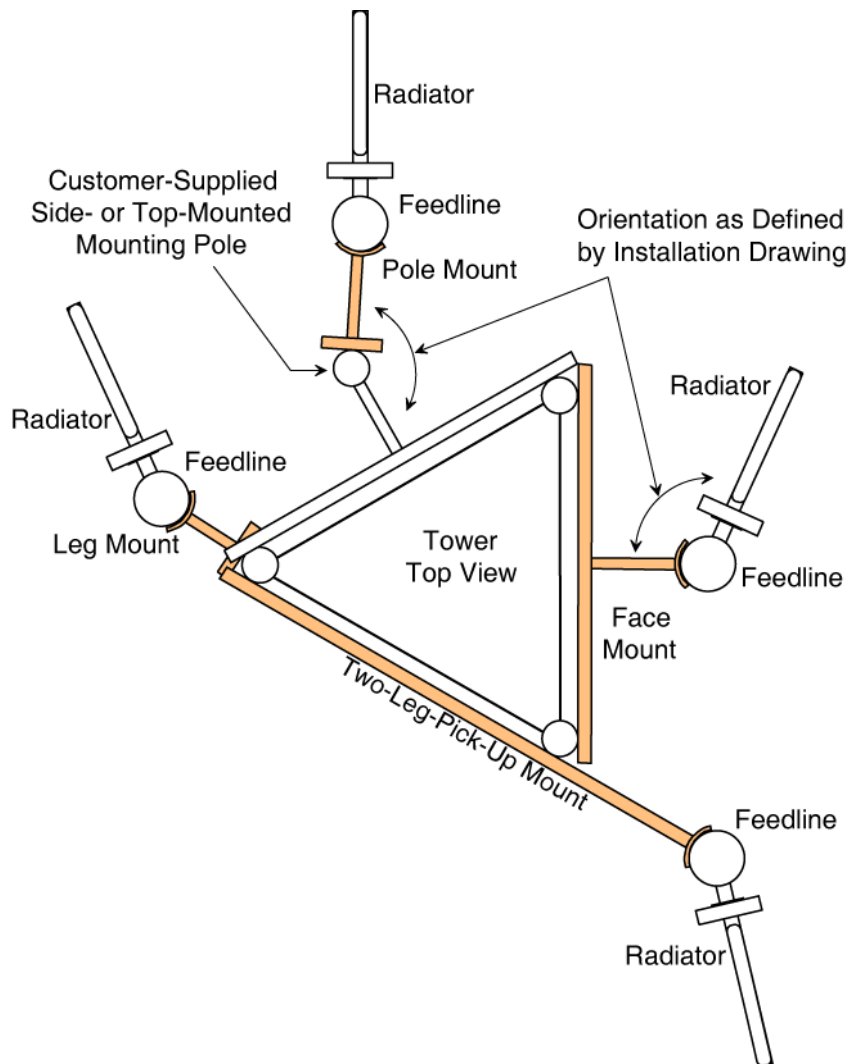

There are four basic feedline mounting styles:

- Leg mount, where the mount attaches directly to a tower leg
- Pole mount, where the mount attaches directly to a customer-supplied mounting pole. The pole may be mounted alongside or atop the tower.
- Face mount, where the mount includes a crossbar which horizontally spans two tower legs.
- Two-leg-pick-up mount, where a crossbar spans two tower legs and extends away from the tower.

Simplified top views of the four styles are shown in [Figure 5](#).

Feedline mounts vary from installation to installation, to accommodate various tower and mounting pole requirements. [Figure 6](#) on page 9 shows several common configurations.

Installing Feedline and Transformer

Figure 6. Common Feedline Mount Configurations

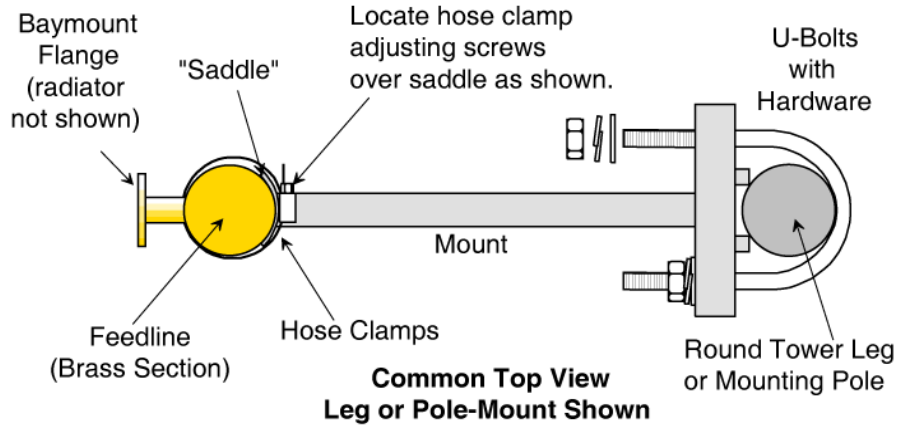

**NOTE**  
You may use anti-seize on U-bolt threads to help prevent galling.

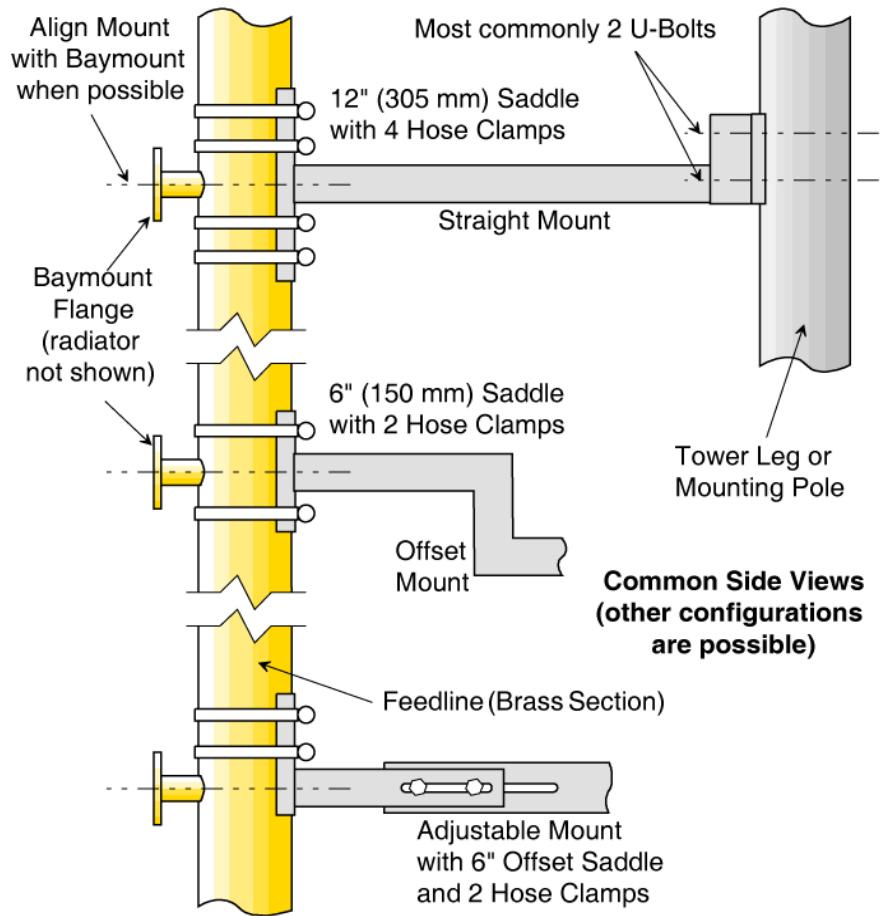

Mounts may vary from bay to bay, especially on tapered towers or where tower obstructions exist. See your installation drawing for your mount configuration and special requirements, if any.

## Installing Feedline and Transformer

Your feedline mounts may be one of the common designs shown; if they are not, they will be shown in detail on your installation drawing.

Before you begin installation, study the mounts, the mounting tower leg(s) or pole, and your installation drawing carefully, establishing which mount(s) will be used for each component.

- a. On the tower, starting at the top, use a steel measuring tape to find the location of the radiator in accordance with the installation drawing. Mark the mount locations.
- b. Mark the specified location of any accessory mounts, such as for the transformer or special coax input line sections, to make sure they will fit as planned.
- c. Watch carefully for any interferences by tower members or guy wires which were not accounted for in the design.
- d. Secure the mounts to the tower leg(s) or mounting pole using U-bolts. Before you fasten the mounts to the tower, scrape the tower paint away to ensure good electrical contact.
- e. After the mounts are installed, touch up any exposed metal on the tower or pole.
- f. When all feedline mounts are in place, sight along them vertically and align them before tightening them.

If any problems appear during this process, please call Shively Labs and discuss them with the installation designer.

---

## Installing the Feedline Sections

- a. Install the feedline section, transformer, and other components carefully, in accordance with your installation drawing and the illustrations in this chapter.
- b. Secure the feedline to the mount saddles using the hose clamps provided (generally, two hose clamps on a 6"-long saddle and 4 hose clamps on a 12"-long saddle). To align the antenna to the proper azimuth, match the stenciled line on the feedline with the weld dot on the top edge of the mount saddle.

### CAUTION

To prevent damage to feedline, be sure the feedline mount saddles are located against the brass portion of the feedline, and position the hose clamp screw housings over the saddles, not against the feedline.

- c. As each feedline section is lifted into place, remove the plastic bags and protective covers from the flanges and install an O-ring, lubricating it with a light coat of petroleum jelly (provided with the antenna).
- d. Secure each feedline section to its mount before installing the next section.



## Installing the Transformer

Figure 7. Transformer Installation, top view

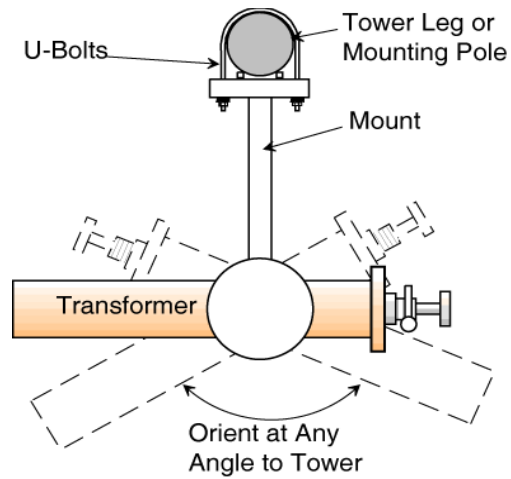

One of the unique features of Shively Labs antenna systems is the adjustable impedance-matching transformer provided with every antenna. It allows the installer to compensate for changes in the input impedance caused by the installation (tower, conduit, ladder, etc.).

### NOTE

The transformer may be oriented in whichever direction you wish (see [Figure 7](#)). Make it easy for yourself to reach for adjustment at startup.

Install the transformer between your transmission line and the feedline. The male end (with the inner conductor connector in place) always goes at the top. Transformer mounts are generally similar to feedline mounts and should be installed the same.



## Before Beginning Startup:

### Important

In the days before the hazards of intense RF power were realized, it was common practice to have a technician climb the tower and adjust the impedance match using the transmitter as a signal source and reading the VSWR or return power on the transmitter. This practice **MUST NOT** be used, as few transmitters can be operated at a low enough power level to avoid exposing the rigger to an unsafe RF level. For reference, see 29 CFR, Section 1910.97, the OSHA standard for exposure to non-ionizing radiation.

To test and adjust VSWR safely, use low-power test equipment, such as a network analyzer or an impedance bridge. If you don't have access to low-power test equipment, please call Shively Labs before proceeding.

### WARNING

Whenever a rigger is on the tower in the area of the antenna, shut off the transmitter signal and lock it off so that it cannot be turned on accidentally.

### WARNING

Low-power test equipment should be used to prevent excessive radiation exposure to the person doing the adjusting.

### Important

*Shively Labs will not accept responsibility for antenna failure after operation without proper purging or positive pressure of dry air or dry nitrogen.*

### CAUTION

When pressurizing the system, never use a "garage" air compressor, as it will not clean the air and will blow both moisture and contaminants such as oil and graphite into the coaxial system.

Be sure to use a good quality pressure gauge which will read accurately in the 5 - 20 psig (35 - 135 kPa) range; don't depend on the cylinder gauge, which will not be accurate at a low pressure.

Do not raise pressure over 20 psig (~135 kPa), even briefly. Note that it takes time for the entire system to fill with the new pressure and the pressure gauge to stabilize.

### CAUTION

Although initial characterization is at your discretion, we strongly recommend it as the best way to identify both initial problems and possible future system damage.

### CAUTION

A high VSWR may indicate damaged transmission line and is likely to cause problems in the future, including serious damage to your equipment.

### CAUTION

If all moisture is not removed from the interior of the system, it will condense when the weather cools. The condensed moisture (water) will cause arcing and permanent physical destruction of the coaxial system, including the transmitter output network.

**CAUTION**

You must blow dry gas *through* the system, not just maintain a pressure. The gas *volume* accomplishes the purge.

**CAUTION**

Never operate the antenna system without proper purging and constant positive dry gas pressure.

---

Pressurization

After the antenna is installed and all lines are connected, it is necessary to check the system for leaks, purge with dry gas (cylinder dry nitrogen or air from a compressor-dehydrator) to remove all moisture, and leave the system pressurized with dry gas to avoid future infiltration of moisture. These steps must be taken before RF power is applied to the system.

Leak Testing

- a. Connect a source of dry gas (cylinder nitrogen or air from a compressor-dehydrator) to the system as shown in [Figure 8](#) on page 15.
- b. Be sure to include a good quality gauge which reads accurately in the 5 - 20 psig (35 - 135 kPa) range; don't depend on the cylinder gauge, which will not be accurate enough in this pressure range.
- c. Pressurize the system to eight (8) psig, then close the shutoff valve. Give the system one half hour to stabilize, then record the pressure and the temperature.
- d. Wait twenty-four hours, then read the pressure and the temperature again and use the formula in the sidebar to obtain a corrected pressure for comparison.
- e. If the system loses pressure at an unacceptably high rate, re-pressurize it, leaving the gas supply on. A rule of thumb is that the final pressure should not be less than half the initial pressure after twenty-four hours.
- f. Find the leak(s), using a leak detector or soap bubbles. (The most common cause of leakage is an O-ring pinched in a flange.)
- g. Correct any leaks that are found. Then repeat the leak test until the results are satisfactory.

**Pressure Correction:**

$$P_C = \frac{(P_R + 14.7)(T_1 + 460)}{(T_2 + 460) - 14.7}$$

where  $P_C$  = corrected final pressure, psig

$P_R$  = final pressure as read, psig

$T_1$  = beginning temperature, degrees F.

$T_2$  = final temperature, degrees F.

Figure 8. Pressurized Gas Schematic

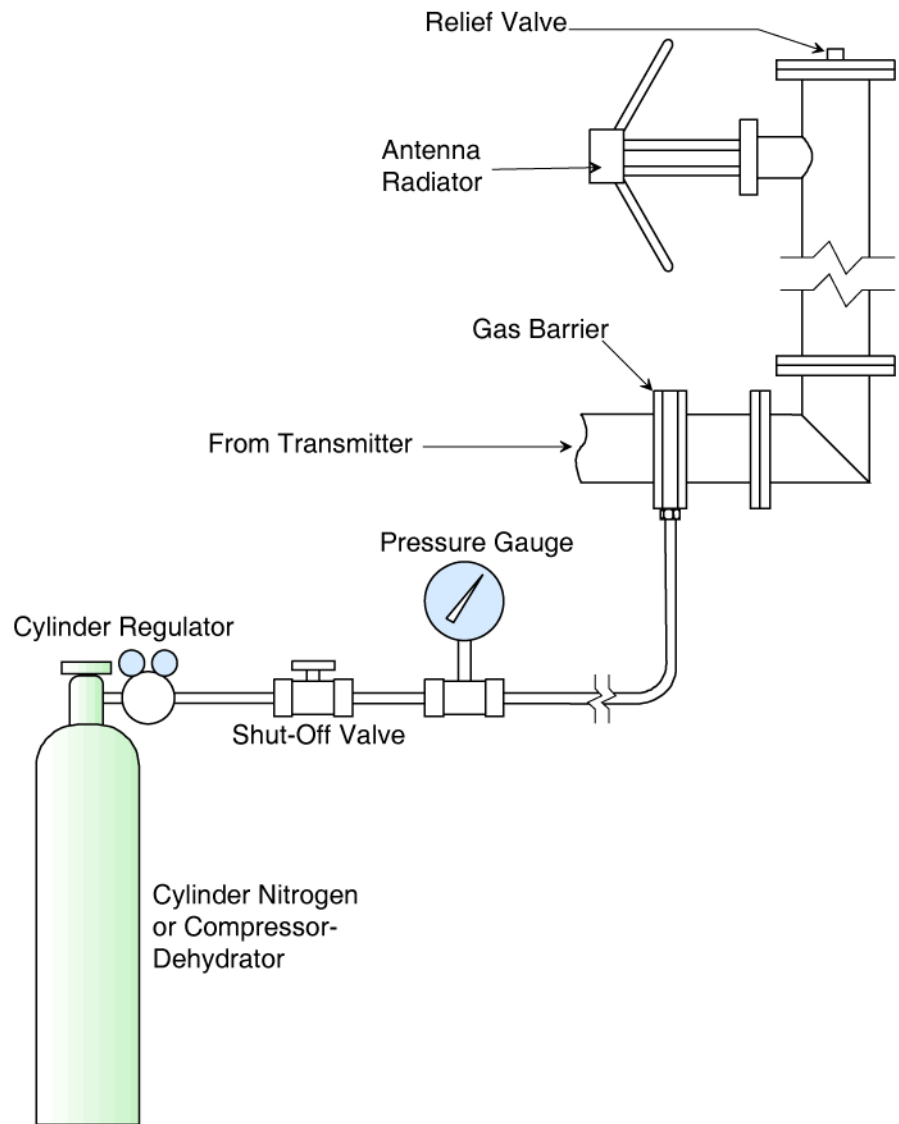

## Purging the System

All pressurized Shively Labs antennas have a pressure relief valve at the top of the feedline (center-fed feedlines have a relief valve at each end). This valve is set to open at about 10 psig. So, to purge the system, it is not necessary to send a worker to the top of the antenna to open a valve or loosen a flange. Simply raise the internal pressure enough to open the relief valve. When the purge is complete, lower the pressure and the valve will close.

When the system is new, and any time that it has been opened, it must be purged with dry gas before operation to eliminate moisture.

The dry gas used may be dry cylinder nitrogen or air from a compressor-dehydrator. Shively Labs suggests three volume changes of dry gas for an "average" system.

Purge your system as follows:

## Startup

- a. Determine how wet the system is. If a system of rigid line carefully protected from weather and assembled in dry weather is average, a system exposed to moisture during storage or installation will be relatively wet. New semi-flex transmission line, delivered pressurized with dry gas, will be relatively dry; used semi-flex will be extremely wet.

### Important

Never apply transmitter power while the antenna is under vacuum.

- b. If you have any liquid water in your transformer or your transmission line, use a vacuum pump to dry the transmission line and transformer. Apply as much vacuum as you can to the system and hold the vacuum for 8 hours. This should remove any liquid water. [A vacuum pump can be rented or borrowed from a refrigeration contractor.]
- c. Determine the volume of dry gas to use for the purge.
- d. [Table 2](#) shows approximate volumes inside various coax sizes. Add the length of the antenna to the length of the transmission line to determine the overall length of the system. You may ignore the volume inside the radiators.

Table 2. Volume of Coax per 1000 Feet of Length

Coax Size	Volume
1-5/8"	13 cu ft. (0.37 m <sup>3</sup> )
3-1/8"	50 cu. ft. (1.4 m <sup>3</sup> )

- e. A standard nitrogen cylinder (9 inch diameter by 55 inches tall) contains about 200 cubic feet (2.6 m<sup>3</sup>) of gas.
- f. Shively Labs Models 1235 and 2577 compressor-dehydrators will provide about 12 cubic feet (0.34 m<sup>3</sup>) per hour; the Model 1234 about 78 cu ft (2.2 m<sup>3</sup>) per hour.
- g. Connect a source of dry gas (cylinder nitrogen or air from a compressor-dehydrator) to the system as shown in [Figure 8](#).
- h. Raise the gas pressure to 12 or 13 psig (83 - 90 kPa).

If the relief valve has opened, the nitrogen cylinder will slowly drain or the compressor-dehydrator will not shut down.

After completion of the purge, reduce the supply pressure to about 5 to 7 psig, allowing the pressure relief valve to close and seal the system.

After the pressure has stabilized, keep careful note of cylinder pressure or compressor-dehydrator running time, to be sure that no large leaks have been overlooked. This is especially important immediately after installation or any subsequent opening and reassembly.

## Leaving the System Pressurized

---

## Initial Characterization (recommended)

Should any problems arise later with your antenna, it will be extremely helpful to know what the system's characteristics were when it was new. We recommend you perform the tests in this section after installation.

The first step is to characterize the transmission line by itself; then add the antenna and characterize the system as a whole. We recommend the following:

### Transmission Line VSWR Reading

Before connecting the antenna, terminate the coax transmission line in an instrument-quality 50-ohm load. Measure and record the voltage standing wave ratio (VSWR). File this information with this manual for future reference.

The VSWR of the transmission line should be within the manufacturer's specifications. If it is, proceed. If not, you should call the manufacturer before connecting the antenna. Problems must be worked out with the design engineer on a case-by-case basis.

### Transmission Line TDR Reading

With the transmission line still terminated in 50 ohms, make a time domain reflectometer (TDR) plot. Label and file the plot with this manual.

### System VSWR Reading

You tested the VSWR of the transmission line alone. Now test the VSWR of the system as a whole.

- a. Remove the load and connect the transmission line to the transformer input, with an O-ring to seal the connection.
- b. Repeat the purge process after sealing the line, in accordance with [Purging the System](#) on page 15.
- c. Measure VSWR. VSWR at this point should be below 1.2 : 1.
- d. Record the reading and file it with this manual.
- e. If VSWR is not satisfactory, check to be sure all the radiators are functioning (see below). If they are, call Shively Labs to help identify the problem.

### Checking Radiator Function

Again using the low-power test equipment to provide a signal to the antenna and read VSWR, have the rigger detune each radiator in turn. The simplest way to detune a radiator is to short across its uprights, for instance with a screwdriver or wrench.

If you have radomes, you don't need to remove each radome to detune the radiator. Have the rigger take a three-foot-square section of chicken wire or a similar metal mesh and place it on the top of each radome in turn, or simply place his hand in the same spot on the flat surface of each radome in turn.

Each time, a deflection in VSWR should be apparent. The deflection for various bays should be similar, but not necessarily identical.

If the VSWR of the array does not change when a radiator is detuned, that bay is not functioning. Check to be sure the radiator was installed properly, including the inner conductor connector.

If you cannot find the problem, please call Shively Labs before proceeding.

## Adjusting the Transformer (Impedance Trimming)

Figure 9. Impedance-Matching Transformer

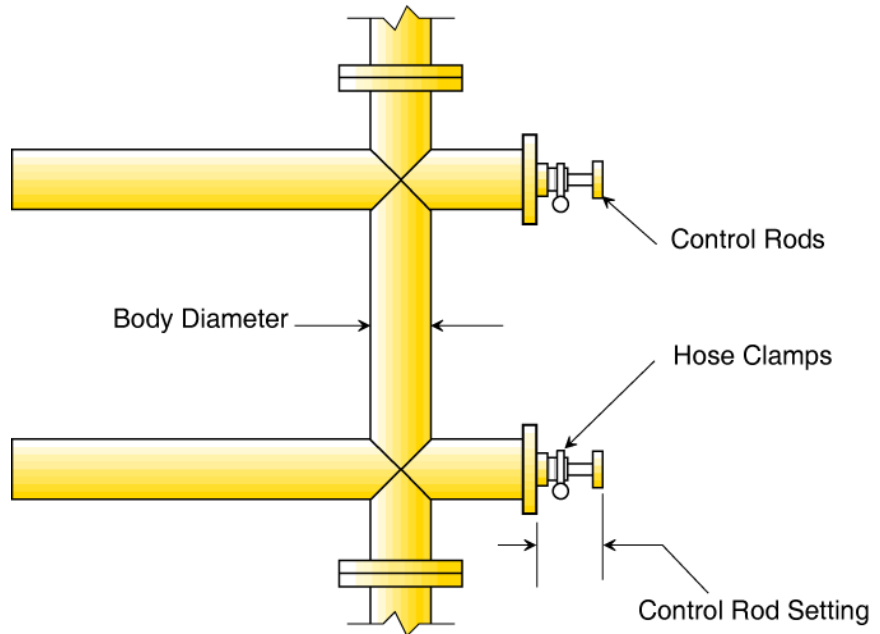

1-5/8" model shown. Others are similar.

The transformer has been factory-adjusted to 50 ohms at your frequency. You will find a scribed line on each control rod shaft. It can be operated at that setting, but it will give optimal performance on your tower if you readjust it after installation.

Adjust the transformer as follows:

- Loosen the hose clamps on the control rods enough to allow the rods to move.
- Grasp either control rod and slide it in or out about 1/4 inch or 6 millimeters. It will move stiffly because of O-ring friction.
- Read the VSWR. If the reading went down, move the control rod again in the same direction. If the VSWR went up, move the same rod in the opposite direction.

Table 3. Factory Control Rod Settings

Nominal Transformer Size	Factory Control Rod Setting <a href="#">Figure 9</a> on page 18
1-5/8"	3-3/4" $\pm$ 1/16" (95 $\pm$ 1.5 mm)
3-1/8"	2-3/4" $\pm$ 1/16" (69 $\pm$ 1.5 mm)
4-1/16"	3-1/2" $\pm$ 1/16" (89 $\pm$ 1.5 mm)



## Startup

- d. Keep adjusting the same rod until no further improvement is seen. Adjust the second rod in the same manner. If you get "lost," return both rods to the factory setting ([Table 3](#)) and start over.
- e. Return to the first rod, and so forth, until you have the lowest possible VSWR or return power reading. This is the optimal transformer setting.
- f. VSWR at this point should be below 1.10 : 1. If it is not, call Shively Labs to help identify the problem.
- g. When you have set the transformer, use a sharp point to scribe the shaft where it leaves the flange collar.
- h. Record the control settings of the two control rods and file this information with this manual for future reference.
- i. Tighten both hose clamps. If the clamps are left loose, vibration may change the adjustments.

---

## Checkout

Before beginning checkout of the antenna system, be sure the following items have been done:

- The antenna system has been installed in accordance with this manual and the installation drawing.
- All radiators are operating; impedance has been trimmed, and VSWR is low.
- The transformer settings and initial characterization data have been recorded.
- The system is gas-tight and purged.

Check the system out as follows:

- a. Bring up RF power slowly and observe transmitter readings, stability, and general operation.
- b. Run at about half power for at least an hour, reading forward and reflected power, stability, etc.
- c. If the system is stable and seems to be operating properly, bring it up to full power. Take initial readings, and repeat the readings periodically.
- d. Performance readings should not change, and there should be no evidence of heating in the antenna system.

If any problem is found, fix it now. Call Shively Labs if you need help or advice.



---

## Precautions

The broadcast industry has recently recognized the potential medical hazards of intense radio frequency radiation. Don't expose personnel to personal harm. For reference, see CFR 29, Section 1910.97, the OSHA standard for exposure to non-ionizing radiation.

### **WARNING**

Whenever a rigger is on the tower in the area of the antenna, shut off the transmitter and lock it off so that it cannot be turned on accidentally.

### **CAUTION**

Never operate the antenna system without proper purging and constant positive dry gas pressure. Shively Labs will not accept responsibility for antenna failure after operation without proper purging or positive pressure of dry air or dry nitrogen.

### **CAUTION**

Don't leave the de-icer on for extended periods when the weather is above 60° F (16° C); it may overheat and be damaged.

---

## The Antenna

Once the antenna has been installed and tested according to this manual, simply apply the transmitter signal. Don't exceed the rated power capacity of the antenna.

To obtain the best performance and dependability from your Shively Labs antenna, read and follow the "maintenance" section of this manual.



Precautions

**WARNING**

Troubleshooting should be performed only by personnel experienced in RF systems and familiar with this equipment.

**WARNING**

The broadcast industry has recently recognized the potential medical hazards of intense radio frequency radiation. Don't expose personnel to personal harm. For reference, see CFR 29, Section 1910.97, the OSHA standard for exposure to non-ionizing radiation. Whenever a rigger is on the tower in the area of the antenna, shut off the transmitter and lock it off so that it cannot be turned on accidentally.

**CAUTION**

Whenever you have the system open for repair, you must purge it again as described in [Purging the System](#) on page 15. Never begin operating the system under power until you are sure all the moisture has been purged from it. You can do permanent damage to the entire system, including the transmitter.

**CAUTION**

VSWR does not change of its own accord. If you find you must repeatedly readjust the transformer to correct the VSWR, find and correct the problem quickly. Otherwise, you will almost certainly burn up your antenna and damage your transmitter. Look for the cause in the following table.

Internal Arcing

Look for the cause of internal arcing in [Table 4](#).

Table 4. Troubleshooting Internal Arcing

Possible Causes:	Cures:
Physical damage to transmission line, feedline, or radiators. Damage may have been caused by ice, lightning, tower work, or many other factors. Damage may cause arcing directly or by allowing water inside the system.	Locate the damage. Replace damaged components. Purge the system after repair, in accordance with <a href="#">Purging the System</a> on page 15.
Missing or misaligned O-ring, if the system has been opened recently.	Locate the O-ring leak, using soap solution. Replace the O-ring if damaged.
Loss of pressurization.	Locate the leak. Re-purge in accordance with <a href="#">Purging the System</a> on page 15 and restore pressurization.

Broad Spectrum RF Noise

This indicates that some metal components are not in good electrical contact with the tower. First, check your antenna mounts, then other tower components, to be sure that the tower paint has been scraped away and that all mounting hardware is tight.

## Troubleshooting

Any metal part in poor contact with the tower will constitute a non-linear junction and cast a broad-spectrum signal. This includes antennas, transmission line, mounts, ladders, and other electrical components.

### High VSWR at Startup or during Operation

High VSWR (Voltage Standing Wave Ratio) is caused by any factor which changes the impedance match between the transmitter and the antenna system.

Look for the cause in [Table 5](#).

Table 5. Troubleshooting High VSWR

(may interfere with other services on the tower)

Possible Causes:	Cures:
Wrong antenna for the application and frequency. Occasionally a customer provides wrong data to Shively or buys a used antenna designed for another application.	Contact your sales representative at Shively Labs.
Split bullet in the transmission line or in the baymount (see <a href="#">Figure 1</a> on page 4). A split bullet is an inner conductor connector misaligned such that one or more of its contact arms is stuck outside the conductor instead of inside. (A missing bullet will cause infinite VSWR.)	Replace the inner conductor connector. It may also be necessary to replace the inner conductor section if it has been damaged.
Mismatched assembly of the antenna. The bays must be paired properly with their respective feedline sections, and the assembly must be exactly as shown in the installation drawing.	Reassemble according to the installation drawing.
Radiators out of sequence (especially on a center-fed, null-filled, or half-wave-spaced system).	Assemble the antenna exactly as shown in the installation drawing and as marked.
Damaged feed strap(s) on a radiator. The feed strap is the brass strip that extends back from the end seal. The length, angle, and straightness of the feed strap are critical to the radiator's performance.	Try to bend the feed strap back to its original shape and angle per the test report in your documentation package. It's brittle and may break; if it does, replace it.
Components of other services have entered the RF field (later installations or broken components).	Remove broken components. Rearrange tower components as necessary to correct the VSWR problem.
Physical damage to the transmission line, feedline, or radiators. This may be from ice, lightning, tower work, or any other source.	Replace damaged components.
Paint has been applied to the radiators, possibly during a recent tower painting.	Remove the paint from the radiators.

### Erratic VSWR During Transformer Adjustment (Impedance Trimming)

If VSWR readings during transformer adjustment as described in [Adjusting the Transformer \(Impedance Trimming\)](#) on page 18 do not respond reasonably consistently to transformer adjustments, then either there is residual water in the transformer, or the transformer is damaged.

Follow this sequence of actions:

- a. Repeat the purging process as described in [Purging the System](#) on page 15.
- b. Try again to trim impedance.
- c. If VSWR is still erratic, Your transformer is probably damaged. Contact Shively Labs.

### Change in Coverage

Changes in broadcast coverage may be caused by the same factors that produce VSWR changes. If coverage seems to have changed, look for VSWR changes and use [High VSWR at Startup or during Operation](#) on page 24 for troubleshooting.

It is important to recognize, however, that apparent changes in coverage may be due to subjective factors or faults of the receiving equipment. Before doing more than checking the VSWR, be sure that an actual coverage change has occurred.

### Pressure Loss or Excessive Gas Usage

If your system will not hold pressure as described in [Leak Testing](#) on page 14, look for the cause in [Table 6](#).

[Table 6. Troubleshooting Pressure Loss or Excessive Gas Usage](#)

Possible Causes:	Cures:
O-ring missing or poorly installed in transmission line, feedline, or baymount flange.	Find the leaky O-ring using soap solution. Replace the O-ring.
Leaky end seal (see <a href="#">Figure 1</a> on page 4).	Replace the leaky end seal.
Loose connecting hardware between line segments or between the baymount and the radiators.	Tighten loose connections when found.
Mechanical damage to transmission line, transformer, or antenna. Check for leaks using soap solution.	Replace damaged components.





---

## Precautions

**WARNING**

Troubleshooting should be performed only by personnel experienced in RF systems and familiar with this equipment.

**WARNING**

The broadcast industry has recently recognized the potential medical hazards of intense radio frequency radiation. Don't expose personnel to personal harm. For reference, see CFR 29, Section 1910.97, the OSHA standard for exposure to non-ionizing radiation. Whenever a rigger is on the tower in the area of the antenna, shut off the transmitter and lock it off so that it cannot be turned on accidentally.

**CAUTION**

When you have had the system open for repair, you must purge it again as described in [Purging the System](#) on page 15. Never begin operating the system under power until you are sure all the moisture has been purged from it. You can do permanent damage to the entire system, including the transmitter.

**CAUTION**

When removing or replacing radiators on the tower, never let the weight of the radiator hang on the inner conductor without bolting. This will damage the connector and possibly the inner conductor itself. Support the weight of the radiator until the flange bolts are tightened.

**CAUTION**

Do not use silicone grease on an O-ring, as this will soften the silicone O-ring.

Use only a light lubricating coat of petroleum jelly (provided); too much may hamper electrical contact and contaminate the interior of the system.

Be sure the O-ring is properly seated in its groove and not pinched between the flange contact surfaces.

**CAUTION**

Be sure to reduce transmitter power in proportion to the number of bays removed. All the power will be directed to the remaining bays and may otherwise burn up the radiators.

---

## Maintenance Log

Shively recommends that you keep a maintenance log; in it record performance parameters such as readings of VSWR and de-icer current draw.

Such a log can be invaluable in spotting and identifying problems. [Sample Maintenance Log](#) on page 29 shows a suggested log form you may use if you like.

---

## Physical Inspection

The antenna system should operate for years with no problem. However, any time you have a rigger up on the tower, it's a good idea to have him check for general condition, looseness of components, de-icer function, and electrical damage. During this inspection, all mounting, flange-connection, and electrical hardware should be tightened.

Keep an eye on dry gas usage. A sudden increase in usage indicates a leak in the system. Troubleshoot per [Chapter 6](#).

---

## Paint

The radiators should never be painted (a coating of paint affects VSWR), and they need no surface protection, since they are made of copper and brass. This includes Teflon or other "ice-prevention" coatings.

It is not necessary to paint the feedline, although no harm will result from doing so.

---

## Radiator Removal for Repair

If a radiator is damaged, it may be removed and returned to the factory for repair. The system can then be sealed with a pressure cap, and operation of the antenna can resume with proportional power reduction and increased VSWR.

### CAUTION

Operating with missing bays may not be possible with some transmitters or antennas that have only a few bays, since some transmitters will not operate into loads with high VSWRs. If in doubt, contact your sales representative at Shively Labs.

For example, the removal of one radiator from a six-bay antenna that has been trimmed to a VSWR of 1.05 : 1 or less will cause the VSWR to increase to 1.2 : 1. The gain will drop to 83% of its former value. Power output should also be dropped to 83% of normal output.

### NOTE

O-rings and flange hardware are provided as spare parts with every antenna. If a new O-ring is not available, the used one may be reused temporarily; lubricate it with a light coat of petroleum jelly when reinstalling it, and replace it with a new O-ring when replacing the radiator.

Remove a radiator as follows:

Release gas pressure.

Remove the radome if applicable, and the radiator, in the reverse sequence of installation ([Chapter 2](#) and [Chapter 3](#)).

### CAUTION

When installing a pressure cap on a baymount flange, be sure that the pressure cap is recessed to clear the feedline inner conductor.

Reseal the baymount flange with a standard-size pressure cap. If you don't have a pressure cap to fit this system, call Shively and we'll rush you one.

Re-purge the system after removing or replacing a radiator (or any other time its seal is broken). If the exposure is brief and in clear weather, a purge of one volume should be sufficient (see [Purging the System](#) on page 15).

Operate the system with power reduced in proportion to the bays removed.

---

Troubleshooting

Troubleshoot the antenna system as described in [Chapter 6](#).

---

Return Policy

When returning any material to the factory, be sure to call your salesman and obtain an authorized return (AR) number first. Use this number in all correspondence. This number helps us to track your returned item. It will expedite repair or replacement and prevent loss of your material.

Sample Maintenance  
Log

DATE	VSWR	GAS PRESS	OBSERVATIONS Visual Inspection of Antenna, Obstruction Lighting; Hardware Checked; Tower Repairs Accomplished; etc.